

1250-7 VERTICAL STYLE MAILBOX

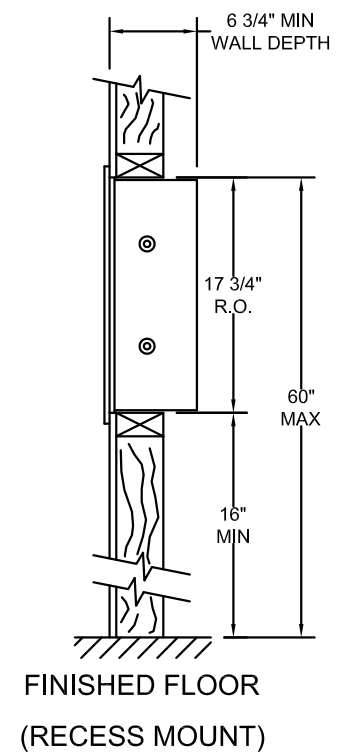
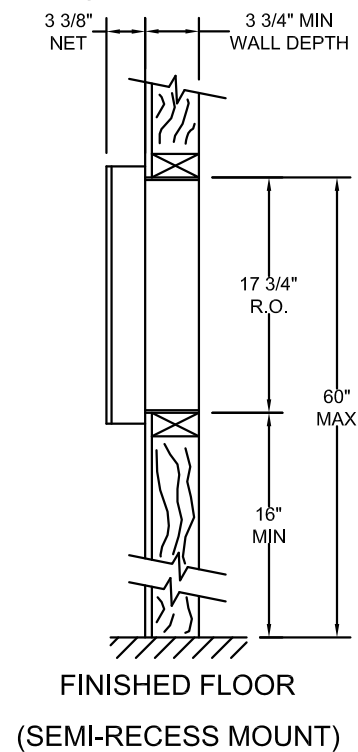
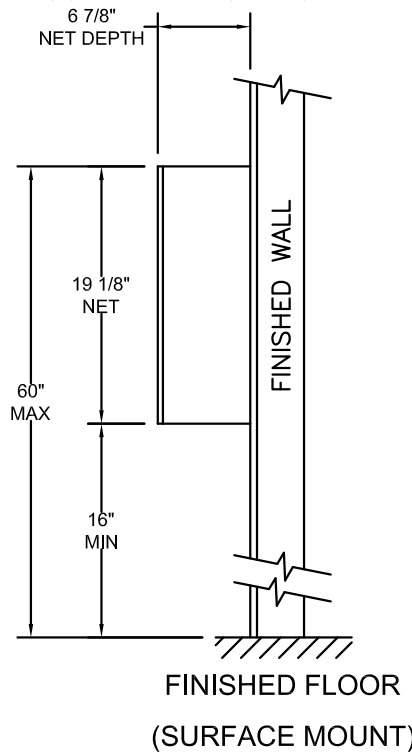
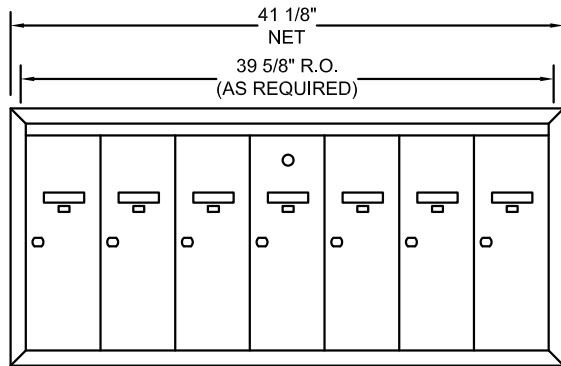

NOTES:

STANDARD:

1. (1) 1250-7 SERIES ALUMINUM CABINET WITH (6) STANDARD SIZE DOORS (16"H X 5 1/2"W), AND (1) STANDARD SIZE MASTER DOOR PREPARED FOR POSTAL MASTER LOCK.
2. CLEAR ANODIZED FINISH.
3. 5-PIN CYLINDER CAM TYPE LOCK WITH (2) KEYS EACH.
4. TENANT NAME CARD HOLDER ON EACH DOOR.
5. RECESSED MOUNT (NO COLLAR REQUIRED).
6. UNIT WEIGHT: 36 POUNDS.

OPTIONAL:

1. PRIVATE MASTER LOCK.
2. POWDER COAT FINISH AVAILABLE IN 10 COLORS.
3. ENGRAVING OR BLACK-FILLED ENGRAVING ON EACH DOOR.
4. OPTIONAL DOORS SIZES AND ARRANGEMENTS.
5. SURFACE MOUNT (WITH SM125-7 COLLAR); SEMI-RECESSED MOUNT (WITH SR120-7 COLLAR).
6. INTEGRAL DIRECTORIES.
7. INTEGRAL DOORBELL PUSH BUTTONS.
8. DOUBLE ROW INSTALLATION (MAINTAIN MAX AND MIN INSTALLATION DIMENSIONS AS SHOWN ON CS5048).